

TP22089

Thermoelectric Cooler Assembly

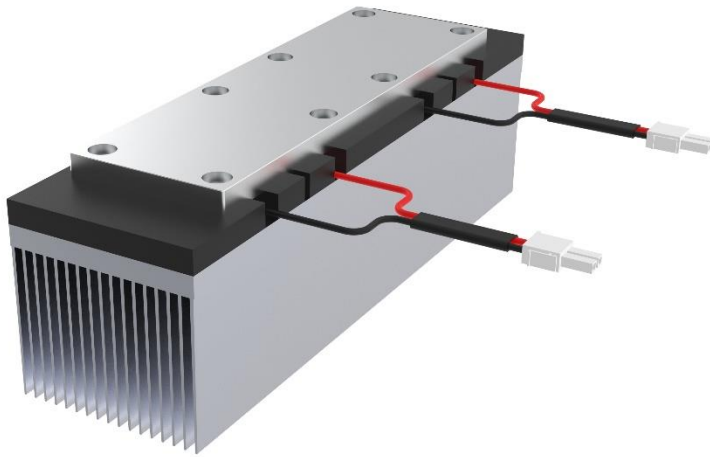

Product Introduction

The thermoelectric Cooler Assembly of this product provides cooling and heat dissipation by directly contacting the cold plate with the cooling object, while the heat is carried away through forced air cooling at the hot end. It is widely used in communication power cabinets, medical equipment, and laser devices. It features a compact design, small size, and high reliability.

Main Features



Modular Design



Compact Structure



High Reliability



Effective Isolation Seal



Length Of Life

Shenzhen Huajing Temperature Control Technology Co., LTD



8/F, Building A1, Qiaode Science Park, No.7 Road, Tianliao Community, Yutang Street, Guangming District, Shenzhen, Guangdong, CN.







TEL: 0755-23405284

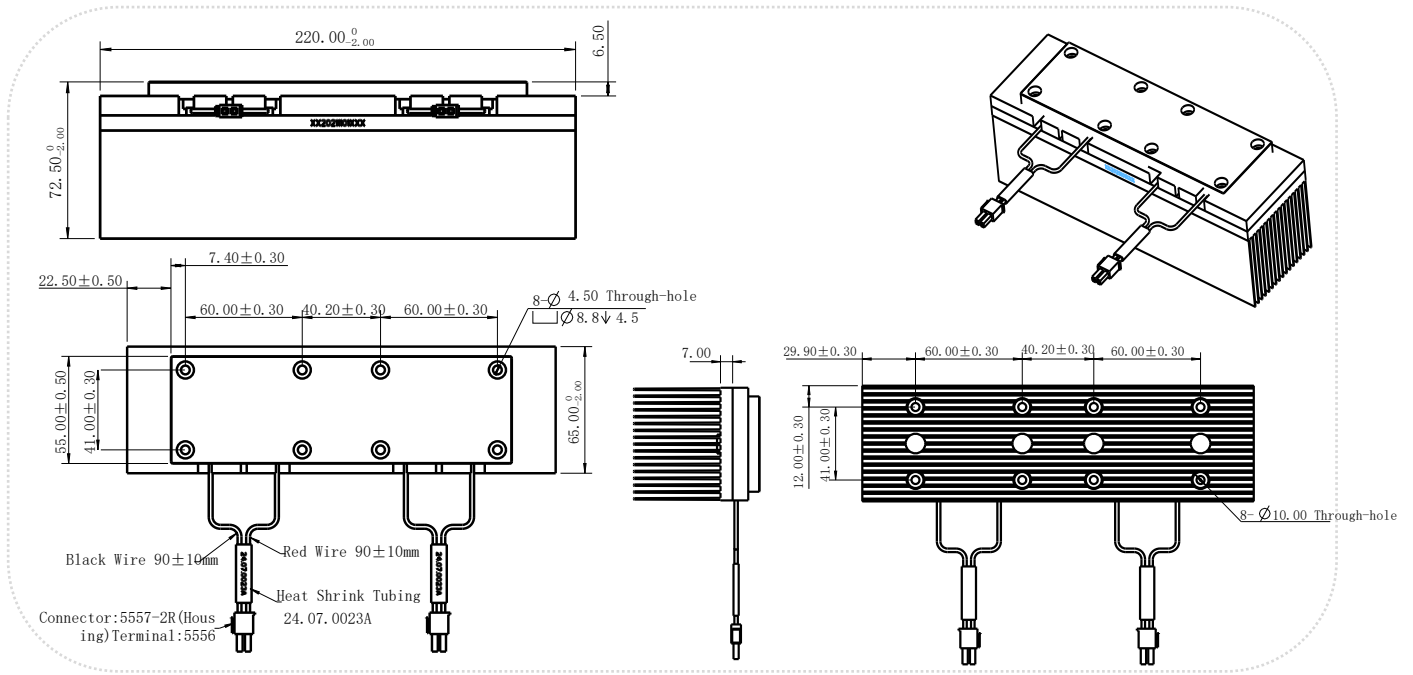

Website: www.huajingtc.com

Outline Dimensions



Name	Thermoelectric Cooler Assembly
Model	TP22089
Operating Voltage (V)	30.8VDC
Operating Current (A)	6.0A
Cooling Capacity (W)	95W ($\Delta T=0$, $T_h=50^\circ\text{C}$)
Dimensions (mm, L x W x H)	220x65x72.5mm
Operating Temperature ($^\circ\text{C}$)	$5^\circ\text{C} \sim 40^\circ\text{C}$
Operating Humidity (%)	15%~85%
Storage Temperature (%)	$-20^\circ\text{C} \sim 60^\circ\text{C}$
Storage Humidity (%)	10%~93%
Net Weight (Kg)	1.0kg
Working Life	1-year warranty, 8-year design lifespan
Applications	 Laser/ Numerical control  Medical/ Beauty  Testing

Shenzhen Huajing Temperature Control Technology Co., LTD



8/F, Building A1, Qiaode Science Park, No.7 Road, Tianliao Community, Yutang Street, Guangming District, Shenzhen, Guangdong, CN.



TEL: 0755-23405284



Website: www.huajingtc.com